

Atlas Copco



DZS A, DZS VSD+A
and DZM VSD+A series

Fixed and Variable Speed
Dry Claw Vacuum Pumps

Fixed and variable speed dry claw vacuum pumps

Our range of dry claw vacuum pumps deliver benefits that include higher productivity, minimized energy consumption, operator-friendly control, easy maintenance, and lower operation costs. They are friendly on the environment – with no contaminated oil to dispose. Dry technology means no exhaust emissions and a clean, reliable performance.



DZS 065-300A



DZS 065-300AP



DZS 100-400 VSD+^A

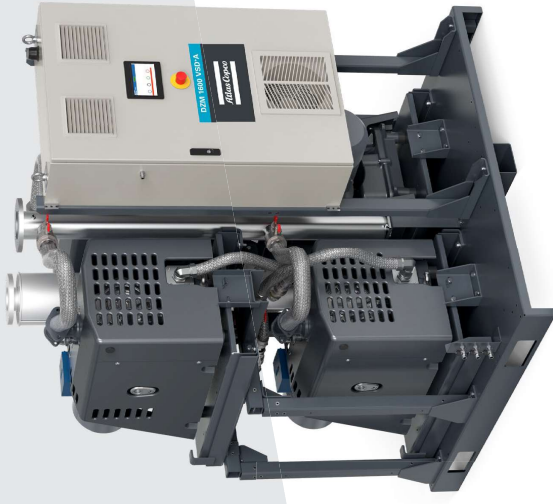

DZM 1200-1600 VSD+^A

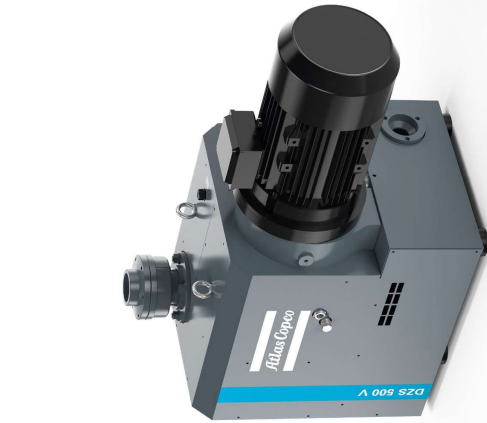

DZS 500-1000 V



DZS 600-1200 VSD+^A



Easy maintenance

Long life bearings and seals, a separate and isolated pumping element, quick access to the pumping chamber make for easy cleaning in the event of product carry-over



Cleverly designed element

Modular design allows flexibility and efficiency in terms of maintenance and life cycle costs



Smart kit (VSD+ and Multi-claw)

Prevents overheating when running at ultimate vacuum



VSD+ drive

Integrated VSD+ inverter drive and pressure setpoint control



Silencer

Reduced noise from the pump and into the work environment



Inlet non return valve

Isolates pump from process when the pump is shut off



Built to last

Innovative construction materials and coatings for a lifetime of reliable operation even in harsh conditions



Wide range

Available in bare shaft, fixed speed IE4 motor and variable speed (VSD+) variants

Bare shaft variant available for DZS 065-300A and DZS 500-1000 V series | Oxygen variant available for DZS 065-300A series only

Introducing the Atlas Copco DZS A Series

The 2nd generation of dry claw vacuum pumps



Improved performance



Better reliability



Easier maintenance



Lower noise levels

DZS 065-300A

The DZS 065-300A series are Atlas Copco's second-generation dry mono claw vacuum pumps. These pumps take it a step further from the previous generation by improving performance and efficiency.

We have re-designed the silencer to ensure lower noise levels, improved on performance with higher pumping speed and increased the reliability by lowering the internal temperature of the pump. You can also expect an improved cost of ownership due to the ease of service and ability to maintain on-site.

The simplicity, robustness, efficiency, and contaminant handling capability of these pumps make them the smart choice for your application.



DZS 065-300AP

The DZS 065-300AP series are reliable pressure variant blowers that deliver low pressure air. These pumps are ideal for production processes such as pneumatic conveying. The pressure variants are compact and can fit into either centralized or decentralized installations.



DZS 100-400 VSD+A

The DZS 100-400 VSD+A series are equipped with a Variable Speed Drive helping achieve increased productivity due to the pressure set point control. These compact machines with small footprint deliver high reliability through a rugged and robust design.



With Bluetooth connection, smartphone control available

DZS 500-1000 V

The DZS 500-1000 V series of dry claw vacuum pumps are contactless vacuum pumps with modular construction consisting of compartments; pumping and gear chambers are separated by using labyrinth seals.

The DZS 500-1000 V series offers low maintenance and continuous duty operations. The pumps are air-cooled and directly driven by a flanged motor via a coupling. A built-in anti-suckback valve installed in the inlet flange will prevent the air from flowing back into the vacuum chamber when the pump is shutdown. PEEKCOAT coating on process wetted parts and rotors make this pump suitable for harsh applications that feature high water vapor loads.



DZS 600-1200 VSD+

The DZS 600-1200 VSD+ series are single stage, oil-free, air-cooled and with the VSD+ inverter drive technology built-in. They are a range of long-life and durable pumps with very low maintenance for rough vacuum applications. These compact machines with small footprint deliver high reliability through a rugged and robust design.

Due to the integrated VSD+ inverter drive and pressure setpoint control, the pump is capable to run with elevated rotor speeds while matching the motor speed to the load coming from the process. The pump can run at it's ultimate vacuum level continuously without overheating.



With Bluetooth connection, smartphone control available

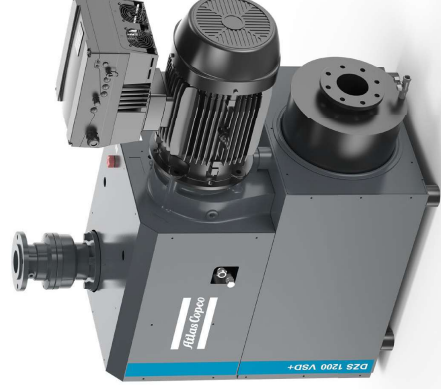

DZM VSD+A - Multi-claw vacuum system

A complete smart multi-claw vacuum pumping system mounted on a skid. The DZM VSD+A system is perfectly designed to meet larger process demands with a central vacuum system. This vacuum pumping package offers a controllable system ranging from 24 to 1,560 m³/h integrated into one platform with a 'plug & play' concept. At the heart of this system is the DZS 300A claw vacuum pump providing efficiency, robustness and better ultimate performance. Driving every DZS 300A pump with a dedicated VSD enables to maximize performance and guarantee stable vacuum level. With two sizes DZM 1200 VSD+A, DZM 1600 VSD+A available and the option to expand the central vacuum system with centrally controlled multiple packages, we can offer a complete turn-key solution.

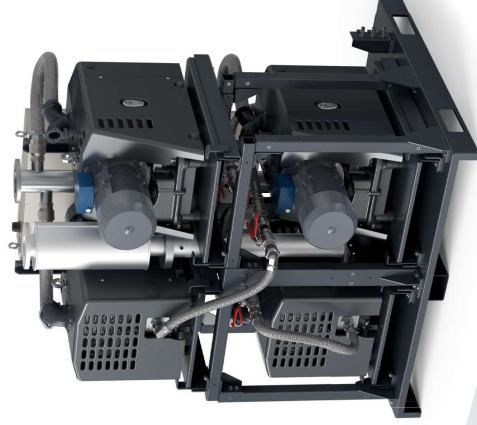
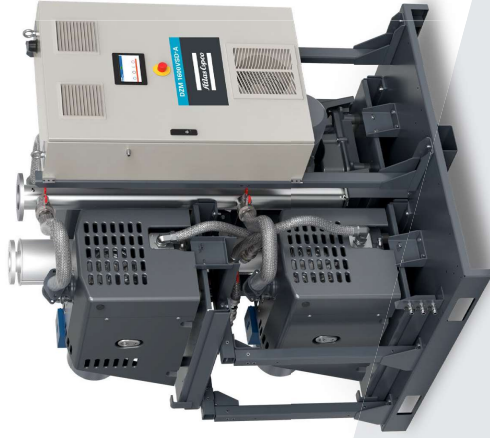

Low noise

Atlas Copco prides itself on offering environmentally friendly solutions and noise level plays a big part. Our reputation for designing and building units with low noise emissions is renowned in the industry.

Plug & play

This concept of design greatly reduces complexity and installation costs compared to other central systems designs. The package not only consists of the pumps but also comprises the common inlet manifold and an exhaust manifold resulting in two simple pipe connections.

Easy maintenance

Uptime and reduced maintenance effort is guaranteed with our central vacuum systems. Easy access to each pump without stopping or needing additional equipment for basic maintenance actions.

VSD+ drive

The DZM multi-claw vacuum system is equipped with 4 Variable Speed Drives (VSD), which guarantees a stable vacuum level at the process, while at the same time maintaining equal running hours between all pumps.

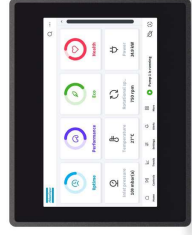

HEX@™ vacuum pump controller

- Automated insights and updates
- Configurable interface
- Secure web-based interface
- Smart functionalities



Scan QR code to know more about HEX@™

Centralized intelligence. Decentralized installation.

At Atlas Copco, we believe that + is more. The pumps are equipped with a VSD+ drive on the motor, enabling PI-Loop functionality as well as multiple options for remote connectivity, including the in-house developed Atlas Copco VSD+ app. We take a static pump and make it intelligent.

Multiple ways to connect to your DZS VSD+ intelligent pump



HMI via smartphone or PC

Start/stop/control/commission, local trending and monitoring



Monitoring

Dashboard, real time, local trending read-out



ModBUS RTU

Pressure, speed, temperature, current, RH, power start/stop/control/commission



HEX@ Grid LINK

Ability to centralize and control multiple pumps, including regulating pressure, speed and start/stop

What if a smartphone could control a vacuum pump?



The Atlas Copco VSD+ app, a unique application for iOS and Android devices, lets you control and monitor a vacuum pump with your smartphone. The VSD+ app allows for ease of commission for your DZS VSD+ vacuum pump by providing 3 parameters - target pressure, start/stop delay and stop level. Start your pump, connect the VSD+ app via bluetooth, enter the desired parameters and you are set to run your pump.



With the VSD+ app you also have live visualization of the actual performance and settings. You can monitor details such as inlet pressure, rotor speed, running hours, service intervals, etc.

*The VSD+ app is available both on App Store and Google Play



Download to find your suitable software for the VSD+ here.

Applications

- CNC routing/clamping
- Plastics (Pneumatic conveying, extrusion)
- Pneumatic conveying
- Vacuum sewage
- Drying
- Sterilizing
- Pick and place
- Central vacuum systems

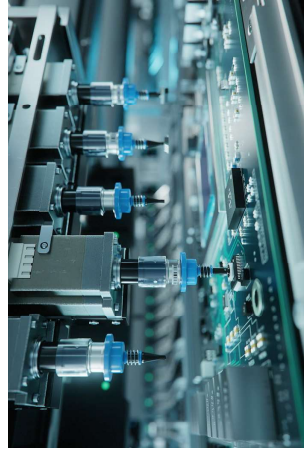
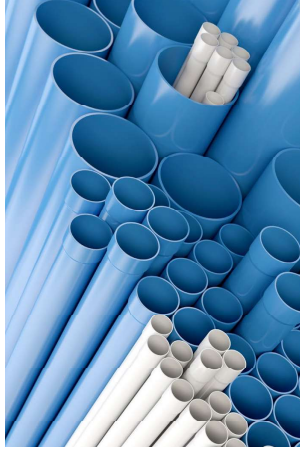
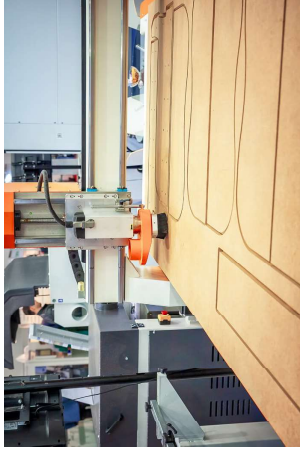

Technical specifications

	Unit	DZS 065A	DZS 150A	DZS 300A	DZS 100 VSD-A	DZS 200 VSD-A	DZS 400 VSD-A
Peak pumping speed (50Hz)	m ³ /h / cfm	65 / 28	150 / 88	300 / 176			
Peak pumping speed (60Hz)	m ³ /h / cfm	78 / 47	180 / 104	360 / 208	105 / 62	189 / 111	398 / 234
Ultimate vacuum continuous	mbar / torr	50 / 37.5	50 / 37.5	140 / 105	50 / 37.5	50 / 37.5	140 / 105
@ 50Hz	kW / hp	1.8 / 2.0	3.7 / 5.0	6.2 / 8.3			
@ 60Hz	kW / hp	2.2 / 3.0	3.7 / 5.0	7.5 / 10.0	3kW / 5hp	5.5kW / 7hp	11kW / 15hp
@ RPM	50Hz / 60Hz	3000 / 3600	3000 / 3600	3000 / 3600	4500	3900	4200
Vacuum connections	Inlet/ Outlet connection*	G 1 1/4"	G 1 1/4" or NPT-G 1 1/4" or NPT	G 2-G 1 1/4" or NPT-G 1 1/4" or NPT	G 1 1/4" or NPT-G 1 1/4" or NPT	G 1 1/4" or NPT-G 1 1/4" or NPT	G 1 1/4" or NPT-G 1 1/4" or NPT
Dimensions	W x H x L (50Hz)	401 x 475 x 879	401 x 475 x 897	501 x 567 x 1036	401 x 565 x 900	401 x 619 x 932	501 x 764 x 1087
	W x H x L (60Hz)	200 / 230 / 380 / 460 / 575	200 / 230 / 380 / 460 / 575	200 / 230 / 380 / 460 / 575	380 / 460	380 / 460	380 / 460
Voltage available	V						
Noise (50Hz / 60Hz)	dB(A)	72 / 75	72 / 75	72 / 75	72 / 76	72 / 76	72 / 76
Operating data	Operating temperature °C / °F	0 to 40 / 32 to 104	0 to 40 / 32 to 104	0 to 40 / 32 to 104	0 to 40 / 32 to 104	0 to 40 / 32 to 104	0 to 40 / 32 to 104
	Oil capacity (Gear box) l / gal	0.7 / 0.185	0.7 / 0.185	1.5 / 0.20	0.7 / 0.185	0.7 / 0.185	1.5 / 0.20

*60Hz and VSD-A models come with NPT adapters

	Unit	DZS 065AP	DZS 150AP	DZS 300AP
Performance	Max. displacement (50Hz)	65 / 29	150 / 88	238 / 140
	Max. displacement (60Hz)	78 / 46	180 / 106	280 / 165
	Max. outlet pressure	1,8	2,3	2,3
Nominal motor power	@ 50Hz	3,7 / 5,0	11 / 14,75	19 / 25,5
	@ 60Hz	3,7 / 5,0	15 / 20,11	22 / 29,5
	@ RPM	3000 / 3600	3000 / 3600	3000 / 3600
Vacuum connections	Inlet/ outlet connection	G 1 1/4" or NPT-G 1 1/4" or NPT	G 1 1/4" or NPT-G 1 1/4" or NPT	G 2-G 1 1/4" or NPT
Dimensions	W x H x L (50 Hz)	401 x 672 x 988	401 x 672 x 1089	501 x 784 x 1310
	W x H x L (60 Hz)			200 / 230 / 380 / 460 / 575
Operating data	Voltage available			200 / 230 / 380 / 460 / 575
	Operating temperature °C / °F	0 to 40 / 32 to 104	0 to 40 / 32 to 104	0 to 40 / 32 to 104
	Oil capacity (Gear box) l / gal	0.7 / 0.185	0.7 / 0.185	1.5 / 0.20

	Unit	DZS 500 V	DZS 1000 V	DZS 600 VSD-	DZS 1200 VSD-
Performance	Peak pumping speed (50Hz)	500 / 294	950 / 558		
	Peak pumping speed (60Hz)	600 / 353	1140 / 670	600 / 353	1140 / 670
	Ultimate vacuum continuous		200 / 150		
Nominal motor power	@ 50Hz	9,2 / 12,3	18,5 / 25		22 / 30
	@ 60Hz	11 / 14,7	22 / 30	11 / 14,7	
	@ RPM				
Vacuum connections	Inlet/ Outlet connection	**BSP(G)3/25"	2850 / 3450		3450
	W x H x L (50Hz)	DN100 PN6 / DN100 PN10		**BSP(G)3/25"	DN100 PN6 / DN100 PN10
	W x H x L (60Hz)	586 x 845 x 1252	680 x 1240 x 1468	586 x 969 x 1362	680 x 1284 x 1460
	Voltage available	586 x 845 x 1310	680 x 1274 x 1434		380V / 460V
Operating data	Operating temperature °C / °F	0 to 40 / 32 to 104	0 to 40 / 32 to 104	0 to 40 / 32 to 104	0 to 40 / 32 to 104
	Oil capacity (Gear box) l / gal	1.5 / 0.4	2.8 / 0.7	1.5 / 0.4	2.8 / 0.7

	Unit	DZM 1200 VSD*A	DMZ 1600 VSD*A
Number of integrated pumps		3 x DZS 400 A	4 x DZS 400 A
Number of VSD pumps		3	4
Nominal displacement	m ³ /h cfm	24 - 1170 14 - 688	24 - 1560 14 - 918
Ultimate vacuum level*	mbar (a) *Hg Vac Torr	150 25,5 112,5	150 25,5 112,5
Dimensions	W x H x L (mm) W x H x L (in)	1575 x 1982 x 1460 62 x 78 x 57,5	1575 x 1982 x 1460 62 x 78 x 57,5
Permissible ambient temperature range	°C °F	0 - 40 32 - 105	0 - 40 32 - 105
Inlet connection size	Flange	*DN 100	*DN 100
Exhaust connection size	Flange	*DN 100	*DN 100
Voltage	V	380 - 460 Vac +/- 10%	380 - 460 Vac +/- 10%
Nominal power	kW hp	33 44	44 59

*For continuous duty/operation

Performance curves

DZS 065A-300A

Fixed speed

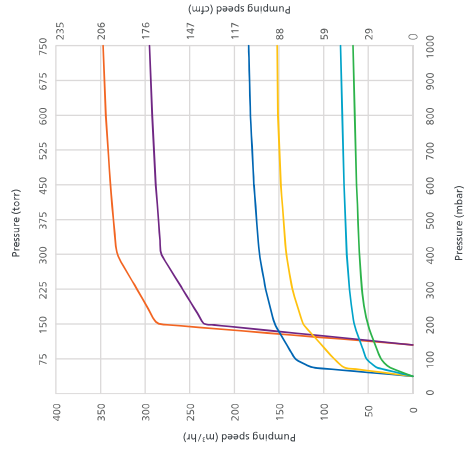

DZS 100-400 VSD*A

Variable speed

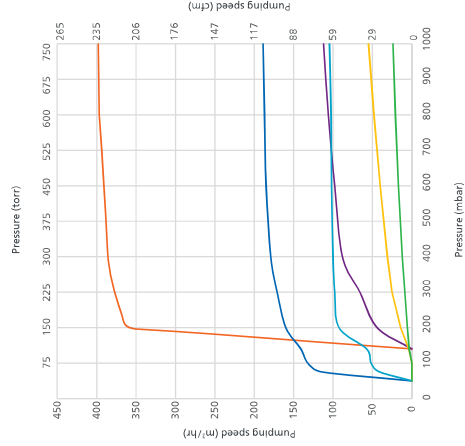

DZS 065-300AP

Fixed speed

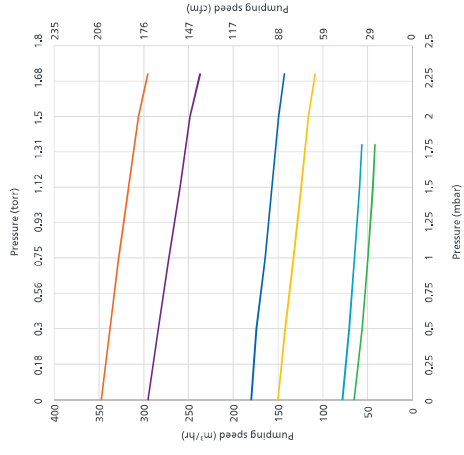

DZS 500-1000 V

Fixed speed

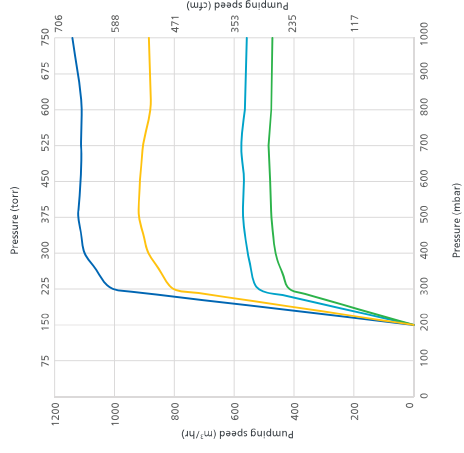

DZS 600-1200 VSD*

Variable speed

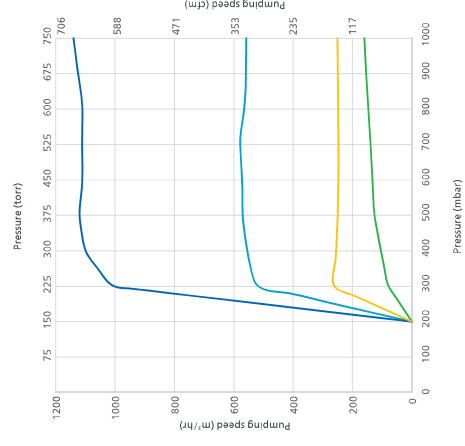

DZM 1200-1600 VSD*A

Variable speed

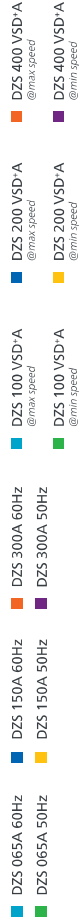
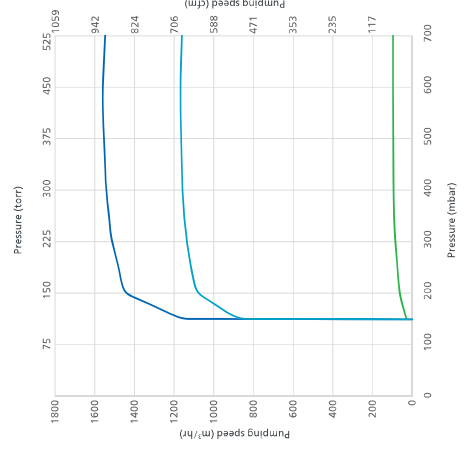

DZS 500 V

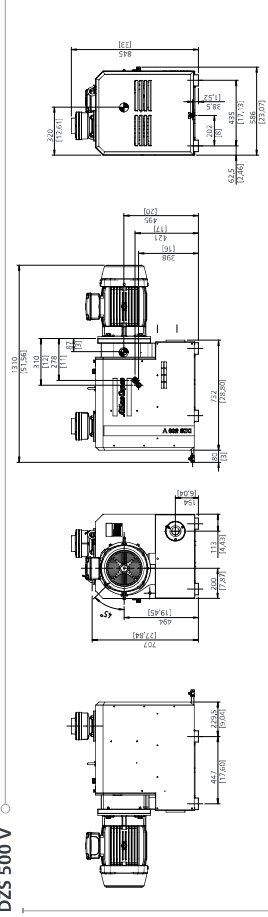

DZS 1000 V

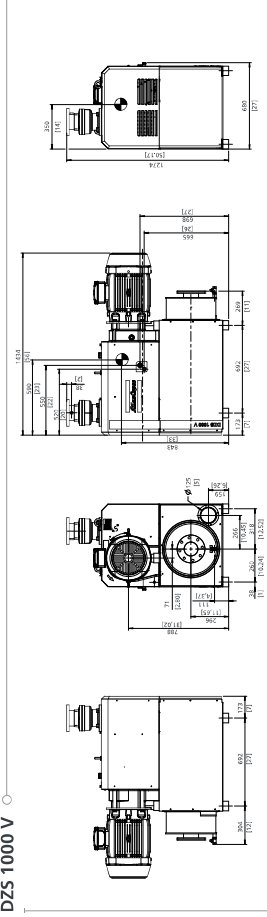

DZS 600 VSD*

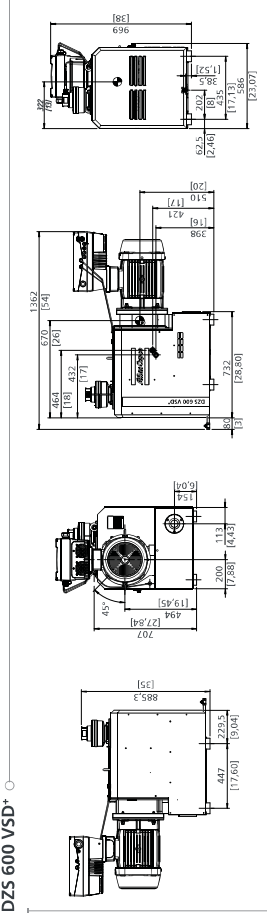

DZS 1200 VSD*

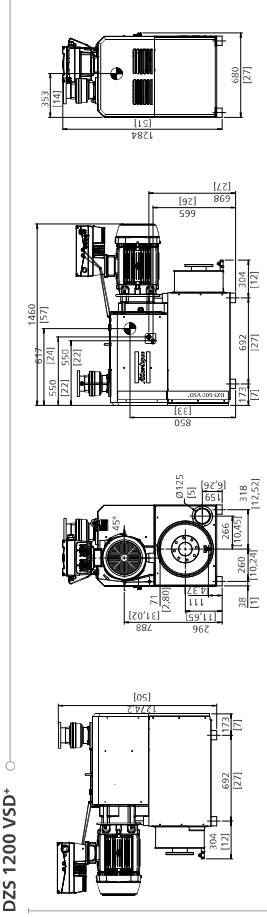

DZM 1200-1600 VSD*A

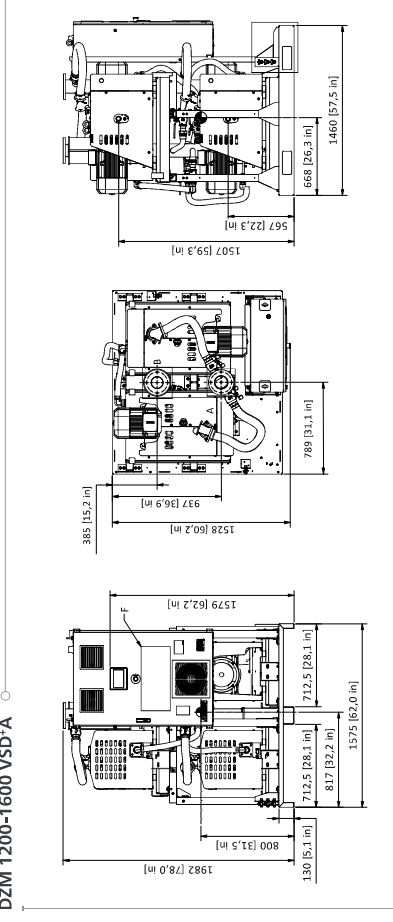

Service solutions Preventive Care



Complete service with our Preventive Care plan

We take over the maintenance planning and responsibility for servicing your vacuum pump on a regular basis. Our Preventive Care plan is tailored to your pump's needs. As your pump is serviced with the latest technology, high levels of energy efficiency are achieved. We will also optimize service events to reduce your total cost of ownership and increase your productivity. This allows you to focus fully on your production.



Cost-effective approach

Regular scheduled maintenance can identify potential problems before they occur and plans can be structured around your individual production situation. Preventive Care enables cost management as you can plan your maintenance costs in advance. In this way, expenses associated with unplanned downtime are minimized.



Maximize the lifetime of your vacuum pumps

Our vacuum specialists are well trained and experts in the field. They will help you to improve uptime and protect your processes. Regular maintenance conducted by one of our vacuum specialists reduces the risk of deterioration. Damaged or worn parts will be replaced with genuine Atlas Copco spare parts to protect your investment and increase the lifespan of your vacuum pumps.



Reliability meets non-stop productivity

We use genuine Atlas Copco spare parts and oil and our services are conducted by vacuum specialists according to manufacturer's recommendations. This enhances your vacuum pump performance, reducing the risk of downtime and enabling your production to run more smoothly.